

PREFADUR, S.L.

Pol. Peña Blanca, Parcela 1. 18657. Nigüelas (Granada)
Tel. 958 780 640; Fax 958 780 640

TUBO Machiembrado 40 x 110 LONGITUD

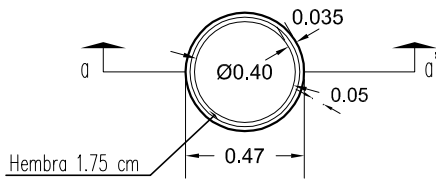

PLANTA

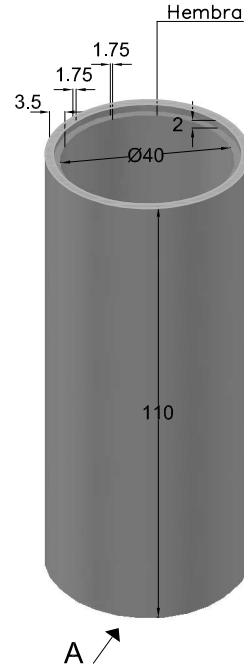

PERSPECTIVA
cotas en cm

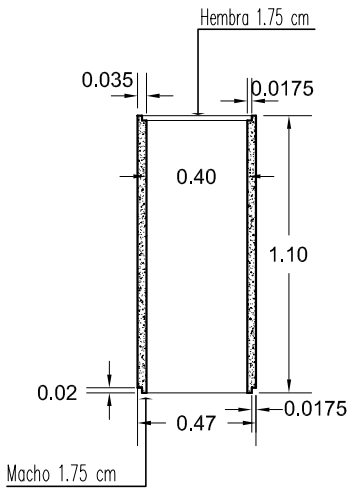

SECCION a-a'

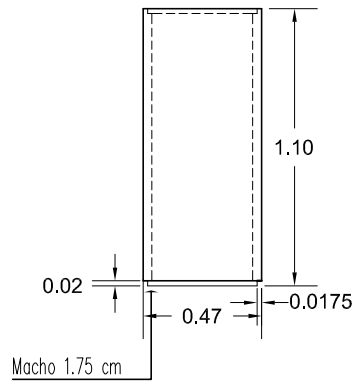

VISTA A

ESCALA 1/30 cotas en m.

CARACTERISTICAS TÉCNICAS:

TUBO MACHIEMBRADO	40 x 110 LONGITUD
TIPO DE HORMIGÓN	HM-250
TIPO DE CEMENTO	CEM-I-42,5 R FYM
PESO (kg/ Unidad)	145 kg