

PREFADUR, S.L.

Pol. Peña Blanca, Parcela 1. 18657. Nigüelas (Granada)
Tel. 958 780 640; Fax 958 780 640

TUBO Machiembrado 120 x 100 LONGITUD

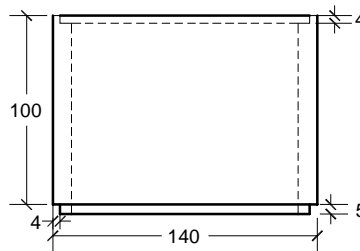
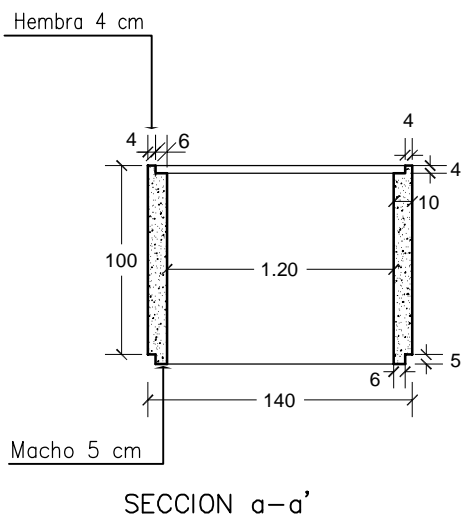
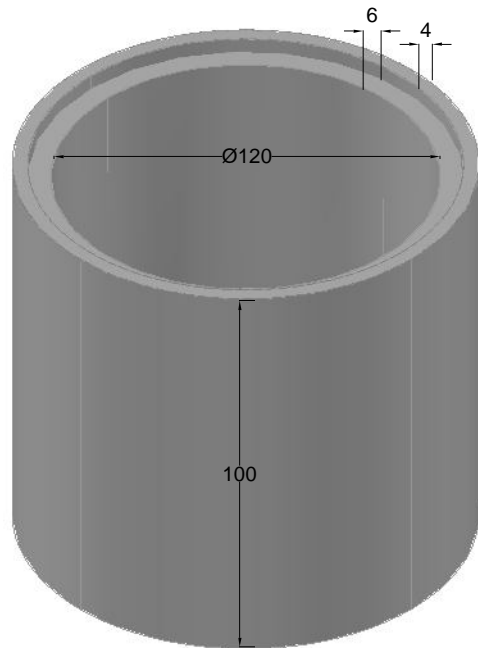
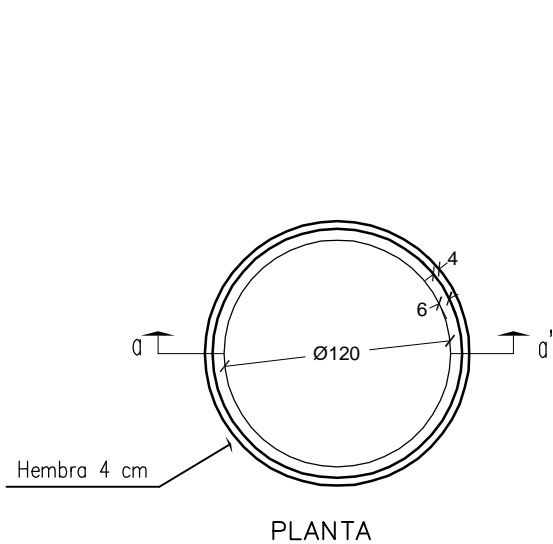

ESCALA 1/40 cotas en m.

CARACTERISTICAS TÉCNICAS:

TUBO MACHIEBRADO	120 x 100 LONGITUD
TIPO DE HORMIGÓN	HM-250
TIPO DE CEMENTO	CEM-I-42,5 R FYM
PESO (kg/ Unidad)	980 kg