

PREFADUR, S.L.

Pol. Peña Blanca, Parcela 1. 18657. Nigüelas (Granada)
Tel. 958 780 640; Fax 958 780 640

ARQUETA A1 a 1.50 ENDESA
61 X 52 X 150

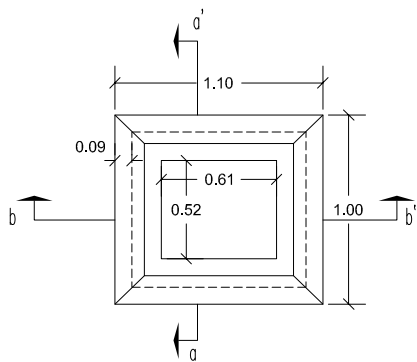

VISTA EN PLANTA

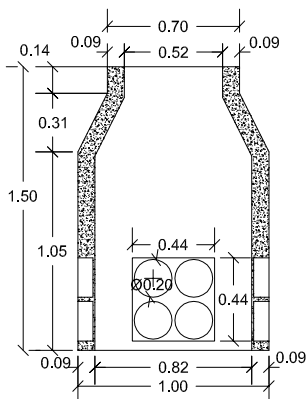

SECCION A-A'

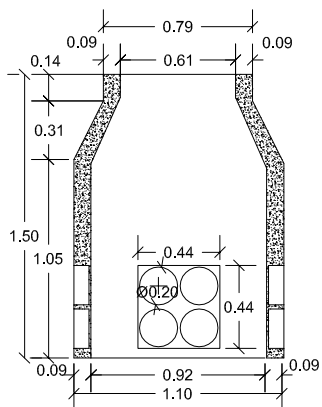

SECCION B-B'

ESCALA 1/40 cotas en m.

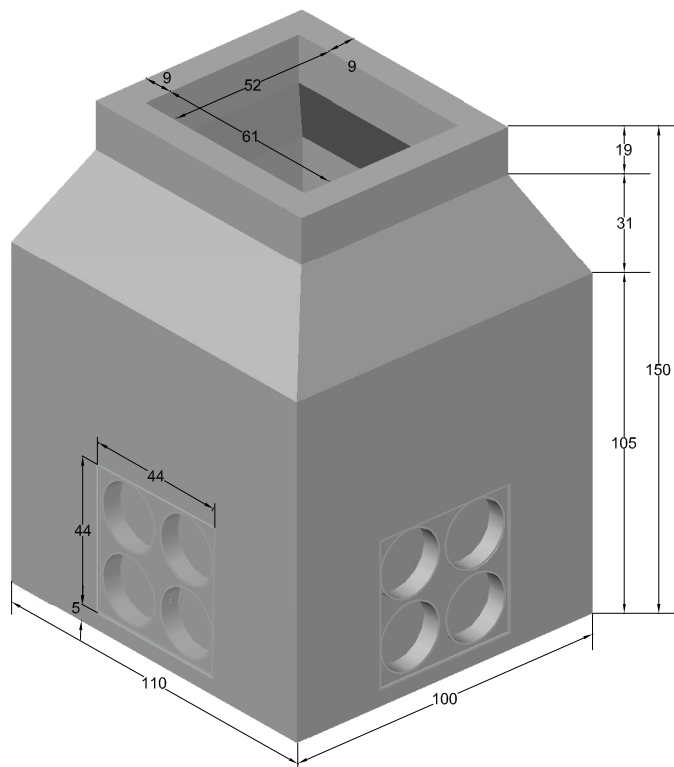

PERSPECTIVA
cotas en cm.

CARACTERISTICAS TÉCNICAS:

ARQUETA A1 a 1.50	61 x 52 x 150
TIPO DE HORMIGÓN	HM-300
TIPO DE CEMENTO	CEM-I-42,5 R FYM
PESO (kg/ Unidad)	1150 Kg.